



## CEILING SYSTEMS

[ Between us, ideas become reality.™ ]

# OPTIMA™ Vector™ ULTIMA™ Vector Installation Instructions

## 1. GENERAL

### 1.1. Product Description

The Vector products referenced in these instructions are made from fiberglass or mineral fiber. Both are 100% downward accessible and are designed to be installed on a conventional 15/16" wide T-bar suspension system. All full panels can be removed and re-installed without the need for access to the plenum. Fiberglass panels are available in 24" x 24", 12" x 24" and 30" x 30" sizes; mineral fiber panels are only available in the 24" x 24" and 12" x 24" sizes.

Only two sides support installed panels. These edges have specially designed kerf details, which allow one edge of the panel to be raised slightly off of the grid flange and then moved out of position. The other two sides are fitted with rabbetted edges, which work to center the panel within the grid opening.

### 1.2. Surface Finish

Both product categories feature the Armstrong DuraBrite™ finish. The surface of these panels is scratch and soil resistant, washable and non-directional. The panel edges are finished with a factory applied paint finish. Optima panels are available with or without CAC backing, and have square edges. Mineral fiber panels have beveled edges.

### 1.3. Storage and Handling

The ceiling panels shall be stored in a dry interior location and shall remain in cartons prior to installation to avoid damage. The cartons shall be stored in a flat position. Proper care should be taken when handling to avoid damage or soiling.

**NOTE:** Vector panels feature exposed edges. Exercise appropriate care to avoid unnecessary contact with the panel edges. Remember that the grid flanges will not conceal panel edge damage.

#### 1.3.1. Working With Fiberglass & Mineral Fiber Products FIBERGLASS CEILINGS

##### MAN-MADE VITREOUS FIBER CEILING PANELS

**▲ W A R N I N G** THIS PRODUCT CONTAINS MAN-MADE VITREOUS FIBERS. POSSIBLE CANCER AND RESPIRATORY TRACT HAZARDS CAN CAUSE TEMPORARY RESPIRATORY, SKIN AND EYE IRRITATION.

**1.3.2. Precautionary Measures:** During the installation be certain that the work site is well ventilated and avoid breathing dust. If high dust levels are anticipated during installation such as with the use of power tools, use appropriate NIOSH designated dust respirator. All power cutting tools must be equipped with dust collectors. Avoid contact with skin or eyes. Wear long-sleeve, loose fitting clothes, gloves and eye protection.

**1.3.3. First Aid Measures:** If contact occurs flush eyes and skin irritation with plenty of water for at least 15 minutes and remove contaminated clothing. After installing material, wash

with warm water and mild soap. Wash work clothes separately from other clothing. Rinse washer thoroughly. Refer to Armstrong MSDS (which includes information on established occupational exposure limits) which are available from Armstrong or your employer.

### 1.4. Site Conditions

Building areas to receive ceilings shall be free of construction dust and debris. Products with HumiGuard™ Plus performance can be installed in conditions between 32°F (0°C) and 120°F (49°C) and in spaces before the building is enclosed, where HVAC systems are cycled or not operating. These products are not recommended for exterior applications, where standing water is present or where moisture will come in direct contact with the ceiling.

### 1.5. Plenum

Installation of Vector panels requires a minimum of space in the plenum, primarily that which is required to install the hanger wires for the suspension system. Three inches (3") is generally accepted as the minimum practical space that is needed to attach these wires. **NOTE:** light fixtures and air handling systems require more space and will determine the minimum plenum height for the installation.

## 2. PANEL EDGES

### 2.1. General

The edges of the Vector panels feature unique edge detailing. The following section is intended to define and explain the function of the edge details.

### 2.2. Access Kerf Edge

The panel edge designated as "A" has a stepped groove detail and is called the access kerf. This edge is the first to engage the suspension system. An arrow printed on the back of the panel will identify this edge.



### 2.3. Registration Kerf

Edge "B" has a single kerf detail that supports the second side and centers the panel in the A - B direction. This edge is referred to as the registration kerf and is opposite edge "A."

### 2.4. Reverse Tegular Edges

The two remaining panel edges are rabbetted to fit between the flanges of the grid system. These edges center the panel in the C - D direction and are called reversed tegular edges.



### 3. SUSPENSION SYSTEM

#### 3.1. General

The suspension system shall be standard 15/16" intermediate duty or heavy duty, double web exposed tee grid. The suspension system, whether new or existing, shall be properly installed and leveled using not less than 12-gage galvanized steel wire. Suspension system installation shall conform to ASTM C-636 requirements.

#### 3.2. Suspension Grid

Vector panels install in a 2' x 2' (30" x 30") module. The main beams shall be spaced 48" (60") o.c. The 48" (60") cross tees shall intersect the main beams at 90° every 24" (30"). The 24" (30") cross tees shall be installed at the midpoints of the 48" (60") tees. The suspension system must be leveled to within 1/4" in 10' and must be square to within 1/16" in 2'. Installation on grid systems that do not meet this tolerance will produce unacceptable panel alignment.

#### 3.3. Stabilizer Bars

Stabilizer bars or BERC Clips are recommended at the perimeters of all installations. While they would only be a code requirement for certain seismic applications, their use greatly improves the installation and removal of the border panels and helps maintain proper panel alignment.

#### 3.4. Vector Seismic Clips

Vector Seismic Clips are available for use on installations in areas of light to moderate seismic activity (Zones 0-2 or SDC A, B & C) and recommended in areas of severe seismic activity (Zones 3-4 or SDC D, E & F).

##### 3.4.1. Clip Application

When used, one clip is required for each panel. Clips should be applied to the grid before the placement of the panels and should be located near the center of the kerfed edges.

#### 3.5. Panel Face Offset

The face of the Vector panel extends 1/2" below the suspension system. The height of components that interface with the ceiling panels, such as sprinkler heads and light fixture trim rings, will have to be adjusted to accommodate this 1/2" offset.

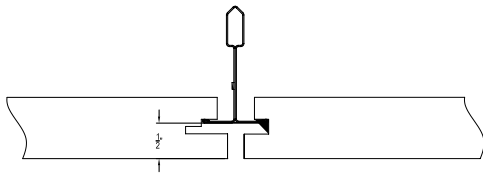

#### 3.6. Panel Penetrations

Holes cut for sprinkler heads and other services that penetrate the ceiling panel must be cut slightly oval shaped to allow the panel to move 1/4" in the direction of the "A" edge. Additionally, trim rings for these devices must be wide enough to accommodate this 1/4" movement.

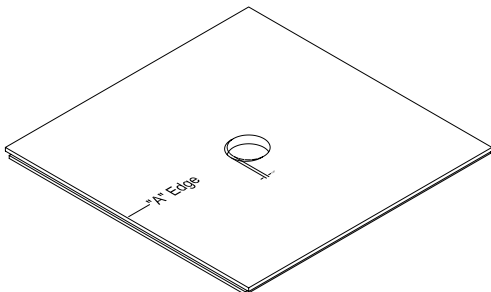

### Panel Installation & Removal

#### 3.7. General

Vector ceiling panels are easily installed and removed from below the suspension system without the aid of tools or special equipment, allowing easy downward access to the plenum.

#### 3.8. Installing Full-Size Panels

The Vector panels are installed in a simple three step process.

STEP 1: Fully insert the deepest kerf of edge "A", the access kerf, onto the exposed grid flange.

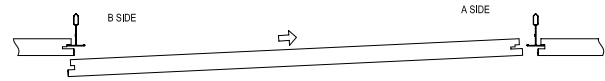

STEP 2: Raise the "B" edge of the panel, the registration kerf, into the grid opening until the kerf lines up with the grid flange.

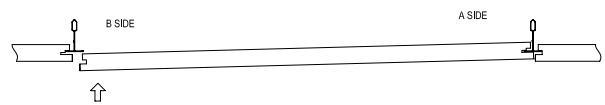

STEP 3: Slide the panel so that the registration kerf on edge "B" engages the grid flange. Ensure that the access kerf on edge "A" drops down into the correct position.

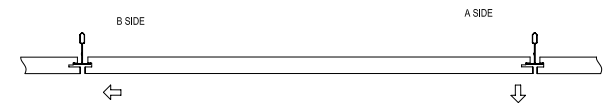

#### 3.9. Orientation of Full Panels

Install all full-size panels with the "A" edge facing in the same direction to provide access consistency. Align panels as you proceed to ensure a uniform reveal width in both directions. **Pay particular attention to this alignment process. Minor variations in placement can be difficult to see from the scaffold, but will become obvious when looking down long runs of panels.**

#### 3.10. Panel Removal

Press on the face of the panel and raise it up to touch the grid. Slide the panel in the direction of the "A" edge (the only way it will move). Allow the "B" edge to disengage the grid flange and drop down out of the ceiling plane. Slide the "A" edge off of the grid. Do not allow the panel to hang on the "A" kerf. Damage could occur, and result in poor alignment when the panel is re-installed.

### 4. PERIMETER DETAILS

#### 4.1. General

Many options are available for perimeter detailing. Regardless of the actual material used, either the grid will rest on the perimeter trim or the face of the panel will. Follow the instructions appropriate for the job conditions.

#### 4.2. Grid Resting on Trim

In a conventional installation of T-bar grid, the face of the suspension system components rests directly on the molding or trim flange. When this detail is used with Vector, the border panels are cut to butt against the molding as shown here.

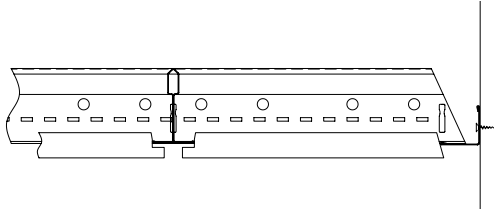

When this option is used, the cut is made parallel to either the C or D edge of the panel. This will retain the "A" and "B" details on opposite sides of the border panel. Panels may be rotated as you move around the walls to retain the kerfed edges.

#### 4.2.1. Measuring the Panel – Straight Cuts

Measure the size of the opening from the edge of the T-bar to the edge of the molding and add  $7/16"$ . Measure and mark the face side of the panel at both edges.

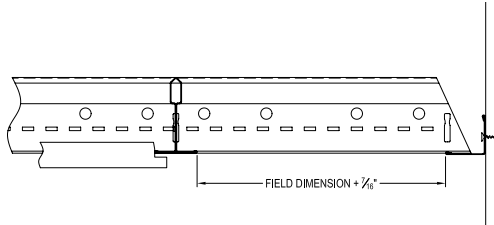

#### 4.2.2. Cutting and Installing the Panel

Cut from the face side using a sharp knife and a straight edge. Install the same as a full-size panel.

#### 4.2.3. Curved and Angled Walls

Panels that meet curved or angled walls can be marked using the same method that is used for standard tegular edge panels. Cut the board large enough to rest on the grid and wall molding as shown in the drawing below.

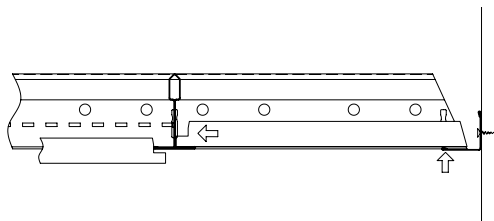

Slide the panel away from the wall until it touches the web of the grid. Scribe and cut the panel to the edge of the wall molding. Install the panel as shown on the drawing in section 4.2.

#### 4.2.4. Corner Panel Installation

Preparation of the corner panel will require the removal of two edges. Mark and cut the panel to retain a portion of the "B" edge. Support the opposite side of the panel by inserting two **Vector Border Clips** as shown in the drawing below. Use **item # 441** with Optima Vector and **item # 440** with Ultima Vector panels. Finish nails or short pieces of hanger wire may be substituted for the Vector Border Clips. These substitutions must be positioned carefully to hold the panel face  $1/2"$  below the support flange of the perimeter trim. Clips are available for use with the panels and are packaged in bags of 24 pieces.

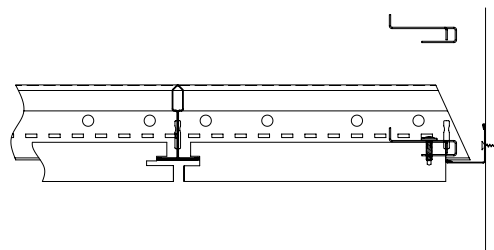

#### 4.3. Panel Resting on Trim

The second perimeter option is to have the grid system raised above the trim by  $1/2"$ . This clearance will allow the face of the panel to pass over and rest upon the support leg of the trim. The following drawing shows Vector terminating at a shadow molding. An alternate option would be to use a standard angle molding but hold the grid  $1/2"$  above the horizontal flange.

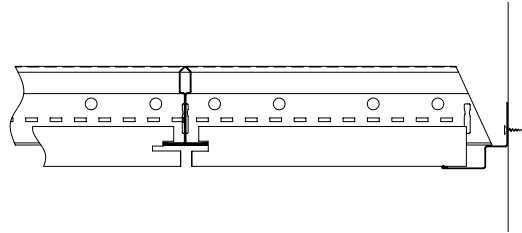

In this installation, the shadow molding has a  $1/2" \times 1/2"$  offset (item # 7875). The grid is resting up on the shoulder and the face of the panel is on the lower flange. This method will create "mouse holes" where the grid passes over the molding flange, but it eliminates field cut panel edges that may be exposed to view.

#### 4.3.1. Measuring the Panel

Measure the distance from the edge of the grid flange to the shoulder of the shadow molding (or wall if you are using angle molding) and add  $1/8"$ . Mark this dimension on the face of the panel, measuring from one of the kerfed edges.

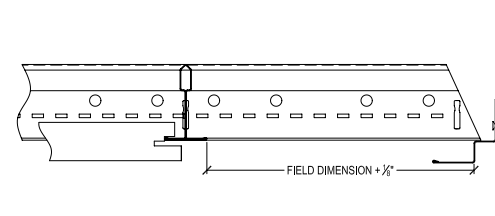

#### 4.3.2. Cutting and Installing the Panel

Cut from the face side of the panel with a sharp knife and a straight edge. Install this panel much like you would a full-size panel. Start with the cut edge going up and over the flange of the molding. Raise the panel up to horizontal and then slide the kerfed edge back onto the grid flange.

#### 4.3.3. Shimming the Border Panels

Insert a wall spring between the edge of the panel and the upper vertical leg of the shadow molding (or wall). Alternately, place a shim cut from corrugated cardboard between the cut edge of the panel and the lower vertical leg of the molding. This step is required to prevent the border panel from disengaging the grid flange and falling from the ceiling. Shims must be carefully sized to prevent any possibility of the panel falling.

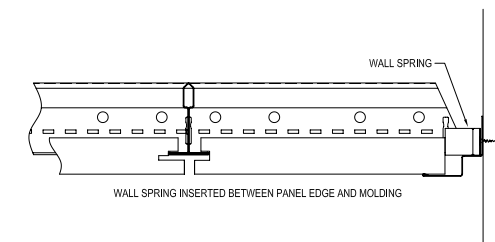

## How to Install a Vector™ Panel

## How to Remove a Vector™ Panel

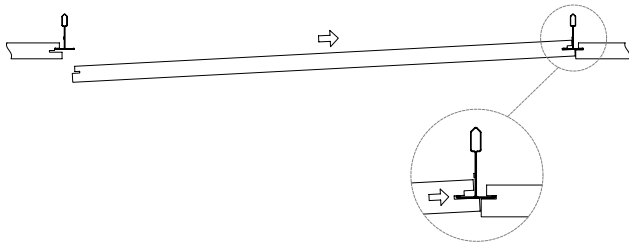

1. Place the deepest portion of the double kerfed edge onto the grid flange.

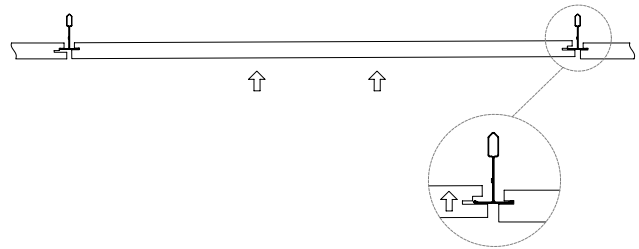

1. Push the panel up against the grid flanges and find the one direction it will move.

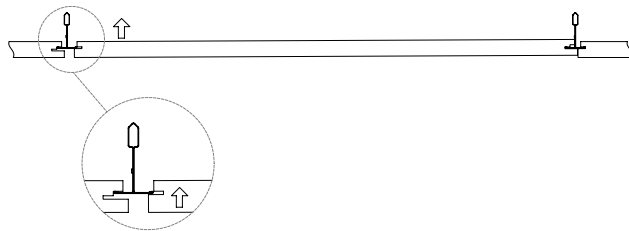

2. Raise the opposite edge up into the grid opening.

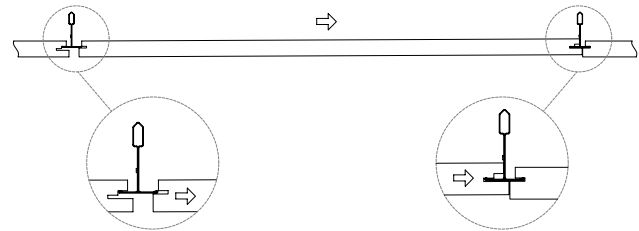

2. Slide the panel until it contacts the adjacent panel.

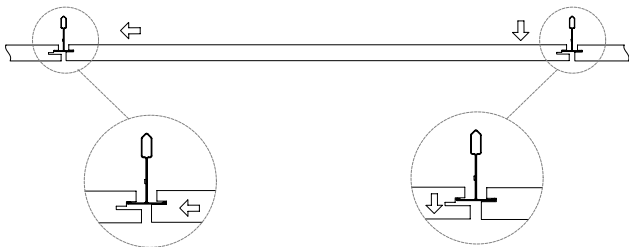

3. Slide the panel back onto the grid flange. Make sure that the first edge drops into position as shown.

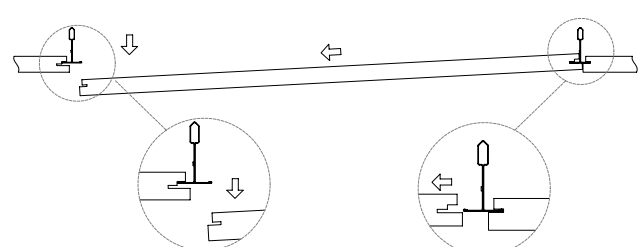

3. Lower the opposite edge out of the grid opening and slide the panel off of the flange. Do not allow the panel to hinge or hang on the grid flange, as this may cause damage to the kerf.

# Vector Border Options

## Grid Resting On Molding

**Vector Seismic Hold Down Clip**  
Using Optima Vector or  
Ultima Vector

-  Vector Seismic Hold Down Clip #442
-  Vector Border Clips #440  
(Mineral Fiber)
-  Vector Border Clips #441  
(Fiberglass)

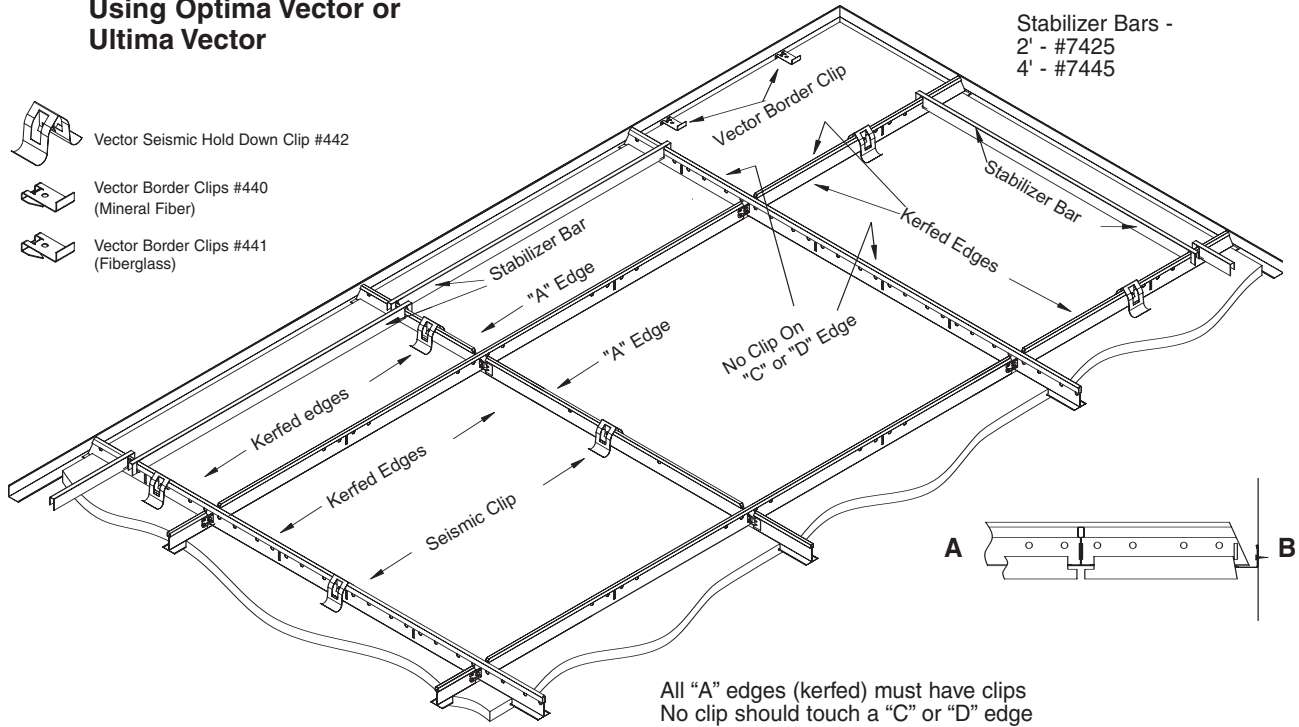

## Panel Face Resting On Molding

**Vector Seismic Hold Down Clip**  
Using Optima Vector or  
Ultima Vector

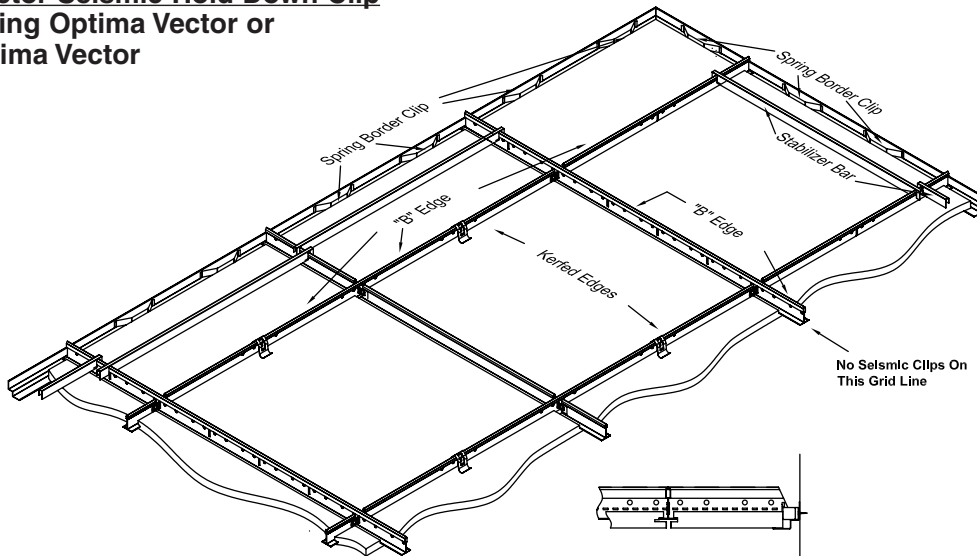

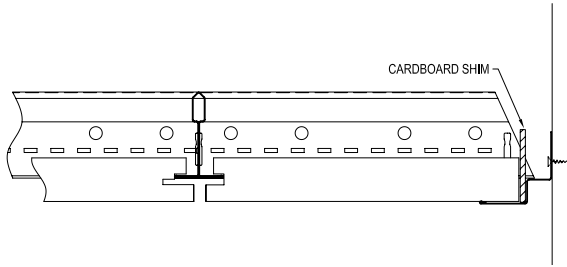

#### 4.3.4. Corner Panel Installation

Preparation of the corner panel will require the removal of two edges. Mark and cut the panel to retain a portion of the "B" edge. Install the panel from above the suspension system and align the "B" edge with the grid flange. Wall springs or shims must be used on two sides to maintain the location of the panel.

#### 4.4. Treating Exposed Edges

Cut panel edges that are exposed to view will have to be treated to look like factory edges. **Armstrong ceiling panel Touch-up Paint (item # 5760) is recommended.**

#### 4.5. Odd-Size Panels

Panels within the field of the ceiling that are less than full size must be cut to replicate factory edges. Special 1' x 2' panels are available to accommodate the use of 1' x 4' light fixtures. An example of a condition that might require a special cut would be odd sized panels next to a linear air diffuser.

##### 4.5.1. Measuring the Panel

Measure, mark and cut the panel 1/4" smaller than the "nominal" dimension required. For example, if the panel is to fit into a nominal 18" x 24" opening it would be cut 17-3/4" wide.

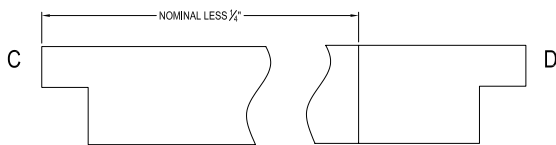

##### 4.5.2. Re-cut the Edge Detail

Turn the panel over and re-cut the reverse tegular edge as dimensioned in the drawing below. Protect the face of the panel from damage.

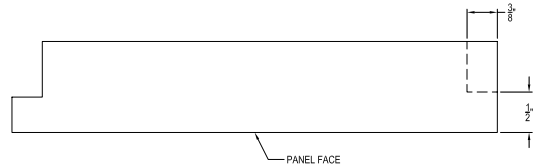

##### 4.5.3. Treat the Cut Edge

Color the re-manufactured edge as described in section 4.4. Allow the paint to skin over before installing the panels. Install like a full-size panel.

### 5. FIXTURE TRIM

#### 5.1. General

The design of the edge details used on Vector creates a gap between the face of the grid and the edge of the panel. This gap is necessary to allow the panel to lift sufficiently to allow installation and removal. This gap may be objectionable when type G light fixtures and air diffusers are used. For this reason, fixture trim kits are available for use with Vector panels.

#### 5.2. Trim Installation

Fixture trims are pre-mitered lengths of plastic molding that snap onto the exposed flanges of the grid at the location of lay-in light fixtures or other accessories that sit into the grid in place of a ceiling panel. Trim elements may be installed before or after the placement of the ceiling panels.

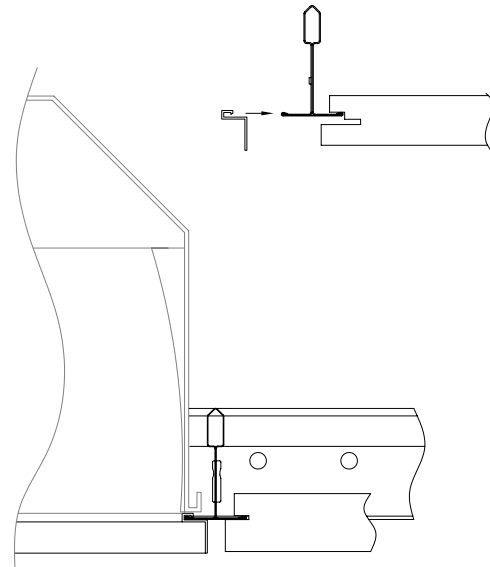

### MORE INFORMATION

For more information, or for an Armstrong representative, call 1 877 ARMSTRONG

For complete technical information, detail drawings, CAD design assistance, installation information and many other technical services, call TechLine™ services at 1 877 ARMSTRONG or FAX 1 800 572 TECH.

For the latest product selection and specification data, visit [armstrong.com/ceilings](http://armstrong.com/ceilings)

All Trademarks are owned by AWI Licensing Company

LA-295591-305J

Printed in United States of America

