

[Between us, ideas become reality.]®

What's New?



armstrong.com/ceilings (search: quikstix)

Drywall Grid System Solutions: QuikStix™ Soffits

- Faster, easier, better solution for installing drop soffits
- Knockouts at 6" or 8" centers reduce cutting time
- Alignment holes make screw installation simple and forms perfect 15, 30, 45, 60 and 90-degree angles
- Flattened bulb is offset to allow true angles without interference
- Bending crimp prevents misalignment
- 90-degree angle fits locking angle molding



Catalog pages 213–216
armstrong.com/ceilings (search: soundsoak)

Custom Soundsoak® Acoustical Walls

- Special sizes
- Fabric-wrapped corners
- Variety of edge details
- Made-to-order panels

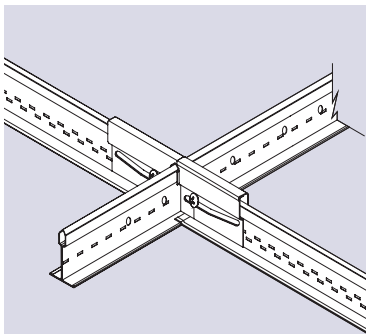
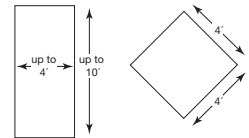

armstrong.com/ceilings (search: joint clip)

Seismic Solutions: Joint Clip SJCG

- Faster, easier, better solution to meeting seismic codes
- Save time with a reliable installation method
- Installs in minutes, no need to cut the face of the grid to install clip
- Easier to keep grid system square
- Allows use of full size panels
- Can be used in Seismic Category D, E, and F ceiling areas exceeding 2500 sf



Catalog pages 142–147
armstrong.com/ceilings (search: techzone)

TechZone™ Organized Ceilings System

- No special grid installation required
- Standard panels create the field
- Standard 6" wide technical panels house services and form the "Tech" Zone
- Easy to organize fixtures in the TechZone
- All elements pre-qualified for fit & finish



Catalog pages 47–48
armstrong.com/ceilings (search: woodworks)

WoodWorks® Linear Curved

- Standard wood plank
- Classic, open reveal style with concealed clip system
- Nominal 4-1/2" and 6" modules, including 3/4" reveals
- Available in rich, natural wood veneers
- Create curved looks with faceted grid
- Edge banding for:
 - Superior quality
 - Aesthetics
- Factory-applied black fleece on each plank to cover the reveal



Catalog pages 35–36
armstrong.com/ceilings (search: effects)

Effects™ Wood Looks Vector Exterior and New Maple

- Vector Exterior panels with powder-coated finish on both sides and wood image on face only
- New Maple finish for interior and exterior application



Catalog pages 164–167
armstrong.com/ceilings (search: formations)

Formations™ Clouds In A Kit

- Faster, easier way to create clouds
- Simple cable connection to structure
- No on-site cuts – less measuring
- No errors or material waste
- Fewer hangar wires, less labor
- Now, available with Knife Edge Axiom® trim and Infusions®, Filaments™, Optima®, Ultima® and MetalWorks™ ceiling panels

[Between us, ideas become reality.]®

What's New?

June 2007



armstrong.com/walls

WOODWORKS® Ekos™ Walls

- New kind of wood wall panels – real wood veneer over mineral fiber core
- Can help contribute to LEED® credits; No detectable formaldehyde emissions, high recycled content
- Variety of accessories in both solid wood and aluminum
- Acoustical perforated panels are standard – absorb up to 55% of sound
- 40% less cost than typical custom millwork
- Easy installation; similar to Soundsoak® acoustical walls



armstrong.com/metalworks
(search: metalworks plank)

METALWORKS™ Plank

- Get a custom metal plank look... with standard, in-stock panels!
- Nothing custom! No long lead times!
- Alternative to more expensive custom systems
- Easy to install with conventional grid and cross-tee method



armstrong.com/woodworks

New Perimeter Trims for WOODWORKS and EFFECTS™ Ceilings

- Perimeter Trims provide continuous and complete wood looks
- Real wood veneered trims and Effects Wood Looks trims both now available
- Custom look using standard components
- Perimeter Trims install quickly and easily with Vector™ and Tegular panels
- New Walnut color in Effects family also available on Vector, Vector Exterior, and Tegular panels



armstrong.com/metalworks
(search: effects)



armstrong.com/cloudsandcanopies

Now – More Cloud and Canopy Options!

- Acoustical and design options
- From translucent Infusions panels to Fabric Filaments™ panels to Metal, Wood, Acoustical Mineral Fiber & Fiberglass
- Provide speech intelligibility for exposed structure spaces
- Options for quick retrofit acoustical solutions
- Many options from Armstrong are shipped and installed in one package, including suspension & trim



armstrong.com/formations

FORMATIONS™ Clouds – Now with Curved Options

- Sixteen new curved configurations
- Clouds appear to float
- Sleek, clean visual
- “Kitted” suspension components and trim for reliable, precise installation
- Components color-coordinated for a consistent look
- Seismic tested for confident specifications



armstrong.com/infusions

INFUSIONS® End-to-End, Side-to-Side Linking Kits

- Playful canopies can now be joined end-to-end or side-to-side
- More design options than ever!
- New dual canopy hanging kits provide clean look with fewer visible wires!
- Watch for new colors, coming Fall '07



armstrong.com/commceilingsna
(search: mesa, fine fissured or cirrus)

High CAC Ceilings

- Effective solutions to acoustical privacy needs
- Broadest range – CIRRUS™, MESA™ and FINE FISSURED™ textures
- Especially relevant for HIPAA requirements as well as offices.
- Considerable costs savings: No need to build walls to the deck or plenum barriers above the ceiling plane

[Between us, ideas become reality.]®

What's New?

October 2007

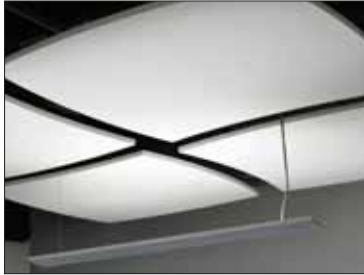

armstrong.com/shapes

SOUNDSCAPES® Acoustical Shapes

- 10 affordable flat, fiberglass panels in multiple sizes and shapes
- Install individually, in groups or at different levels
- 7 color options
- 3 kinds of installation options
- Improve sound absorption and reverberation time in open spaces

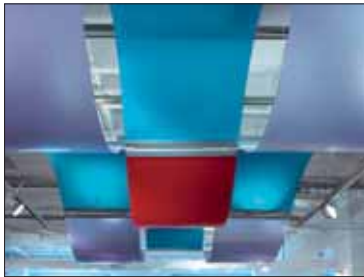

armstrong.com/infusions

INFUSIONS® Accent Canopies

- New large size 4' x 10' canopies in 5 channeled polycarbonate colors
- 5/8" thick panel; nominal 4' long extrusions
- Integrates with existing hanging and linking kits
- 6 new solid colors for 2' x 5' and 2' x 6' canopies
- Mix and match sizes, shapes and colors



armstrong.com/filaments

FILAMENTS™ Fabric Covered Panels

- 30 new, bold, special order colors/finishes
- Coordinate with Soundsoak® Acoustical Walls, Formations™ Clouds and some office furniture collections
- Color-coordinated grid selections in RAL colors; custom colors available



armstrong.com/woodworks

WOODWORKS® Linear Planks Now With Bamboo Veneer

- The hottest look in 2' x 2's is now available for linear planks!
- Bamboo Patina and Bamboo Native veneers
- The linear look of bamboo combined with linear planks provides a great visual
- Can help contribute to LEED® MR6 credit



armstrong.com/lineage

LINEAGE™ Wood Looks Laminate Planks

- Natural, consistent wood-grain look
- Economical alternative to custom millwork
- Pre-finished, durable surface
- Maintenance-free; easy installation
- Paintable (Item 1480WHT)

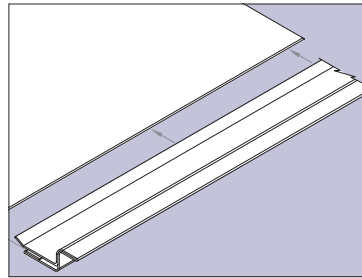

armstrong.com/metalworks

METALWORKS™ Edge Caps Accessories

- Coordinates with Tegular and Vector 2' x 2' ceilings
- Clean look on field-cut panels
- 3 MetalWorks colors
- Improves cut panel installations



armstrong.com/drywallgrid

Acoustical Locking Angle System

- Engineered solution for congested corridor plenum spaces
- Enhances the use of Optima® Vector™ Plank
- System includes: 12' Acoustical Locking Wall Angle; 12' Locking Wall Angle Track; Locking Wall Angle Gusset

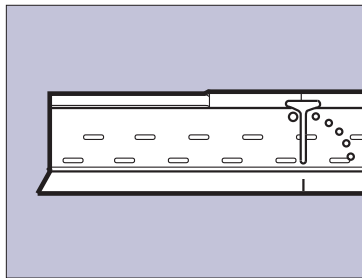

armstrong.com/drywallgrid

QUIKSTIX™ Drywall Ceilings Locking Pocket Main Beams

- Faster solution for installing up tight drywall ceilings and corridor transitions
- Uptight Clip allows installation in 2" plenums; adjustable to uneven deck surfaces

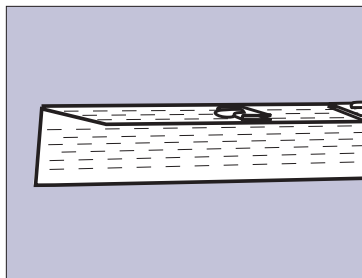

armstrong.com/drywallgrid

Pre-Rock Locking Angle Molding

- Faster solution for two-phase gypsum board application
- Pre-engineered locking tabs punched 8" on center
- Eliminates screws, pop rivets, or crimpers to attach tees to molding

